

По вопросам продаж и поддержки обращайтесь: btn@nt-rt.ru

www.bently.nt-rt.ru

Архангельск (8182)63-90-72,
Астана+7(7172)727-132,
Белгород(4722)40-23-64,
Брянск(4832)59-03-52,
Владивосток(423)249-28-31,
Волгоград(844)278-03-48,
Вологда(8172)26-41-59,
Воронеж(473)204-51-73,
Екатеринбург(343)384-55-89,
Иваново(4932)77-34-06,
Ижевск(3412)26-03-58,
Казань(843)206-01-48,
Калининград(4012)72-03-81,
Калуга(4842)92-23-67,
Кемерово(3842)65-04-62,
Киров(8332)68-02-04,

Краснодар(861)203-40-90,
Красноярск(391)204-63-61,
Курск(4712)77-13-04,
Липецк(4742)52-20-81,
Магнитогорск(3519)55-03-13,
Москва(495)268-04-70,
Мурманск(8152)59-64-93,
Набережные Челны(8552)20-53-41,
Нижний Новгород(831)429-08-12,
Новокузнецк(3843)20-46-81,
Новосибирск(383)227-86-73,
Орел(4862)44-53-42,
Оренбург(3532)37-68-04,
Пенза(8412)22-31-16,
Пермь(342)205-81-47,
Ростов-на-Дону(863)308-18-15,

Рязань(4912)46-61-64,
Самара(846)206-03-16,
Санкт-Петербург(812)309-46-40,
Саратов(845)249-38-78,
Смоленск(4812)29-41-54,
Сочи(862)225-72-31,
Ставрополь(8652)20-65-13,
Тверь(4822)63-31-35,
Томск(3822)98-41-53,
Тула(4872)74-02-29,
Тюмень(3452)66-21-18,
Ульяновск(8422)24-23-59,
Уфа(347)229-48-12,
Челябинск(351)202-03-61,
Череповец(8202)49-02-64,
Ярославль(4852)69-52-93

Описание на передатчики показаний скорости. Модель 190501



BENTLY
Nevada

190501 Velomitor* CT Velocity Transducer

Bently Nevada* Asset Condition Monitoring



Description

The Velomitor* CT Velocity Transducer is a low-frequency version of our standard Velomitor Piezo-velocity Sensor. Its design specifically measures casing vibration velocity on cooling tower and air-cooled heat-exchanger fan assemblies that operate at or above 90 rpm (100 to 300 rpm typical). The Velomitor CT Transducer can measure vibration amplitudes at these frequencies as well as the vibration frequencies generated by the fan motor and speed reducer.

Application Advisory

If you plan to make housing measurements for overall protection of the machine, consider the usefulness of the measurement for each application. Most common machine malfunctions (imbalance, misalignment, etc.) originate at the rotor and cause an increase (or at least a change) in rotor vibration. For any housing measurement alone to be effective for overall machine protection, the machine must faithfully transmit a significant amount of rotor vibration to the bearing housing or machine casing, or more specifically, to the mounting location of the transducer.

Exercise care when physically installing the transducer. Improper installation can degrade the transducer's performance, and/or generate signals that do not represent actual machine vibration.

Upon request, we can provide engineering services to determine the appropriateness of housing measurements for the machine in question and/or to provide installation assistance.



imagination at work

Specifications and Ordering Information
Part Number 141636-01
Rev. Y (05/14)

Page 1 of 13

Specifications

Parameters are specified from +20 °C to +30 °C (+68 °F to +86 °F) and 100 Hz unless otherwise indicated.

Note: Operation outside the specified limits will result in false readings or loss of machine monitoring.

Electrical

Sensitivity

3.94 mV/mm/s (100 mV/in/s) ±5%.

Frequency Response

3.0 Hz to 900 Hz (180 to 54,000 cpm) ±1.0 dB

1.5 Hz to 1.0 kHz (90 to 60,000 cpm) ±3.0 dB

Temperature Sensitivity

-8% to +5% typical over the operating temperature range.

Velocity Range

63.5 mm/s pk (2.5 in/s pk) (see Figure 4 and Figure 5). Vibration components in excess of 10g pk above 1 kHz can significantly reduce this range.

Transverse Response

Less than 5% of the axial sensitivity.

Amplitude Linearity

±2% to 63.5 mm/s pk (2.5 in/s pk)

Mounted Resonant Frequency

9 kHz, minimum (stud mounted, except quick disconnect)

Output Bias Voltage

10.1 Vdc ± 1.0 Vdc, Pin A referenced to Pin B

Dynamic Output Impedance

<400 Ω typical

Broadband Noise Floor (1.5 Hz to 1 kHz)

0.229 mm/s (0.009 in/s) pk. See Figure 6 for typical noise floor.

Base Strain Sensitivity

0.43 mm/s/μstrain (0.017 in/s/μstrain).

Grounding

Internal electronics are isolated from case.

Maximum Cable Length

305 metres (1,000 feet) of cable (part number 02173006) with no degradation of signal. Note: Maximum continuous length of cable available is 300 feet. If longer lengths are required they must be spliced or have a connector installed on them.

Hazardous Area Approvals


Multiple approvals for hazardous areas certified by Canadian Standards Association (CSA/NRTL/C) in North America and by LCIE in Europe.


North America:

Ex ia/AEx ia IIC T4
Class I, Div 1 Groups A, B, C & D
Class II, Groups E, F, and G
Class III
When installed per dwg 167536
T4 @ -40°C ≤ Ta ≤ 100°C

Ex nL/AEx nA IIC T4
Class I, Div 2 Groups A, B, C & D
When installed per dwg 167536
T4 @ -40°C ≤ Ta ≤ 100°C

ATEX:

 II 1 G
Ex ia IIC T4 Ga
T4 @ -40°C ≤ Ta ≤ 100°C

 II 3 G
Ex nA IIC T4 Gc
T4 @ -40°C ≤ Ta ≤ 100°C

IECEX

Ex ia IIC T4 Ga
Ex nA IIC T4 Gc
T4 @ -40°C ≤ Ta ≤ 100°C

Brazil:

Ex ia IIC T4 Ga
-40 °C ≤ Ta ≤ +100 °C
Ex nA IIC T4 Gc
-55 °C ≤ Ta ≤ +121 °C

For further certification and approvals information please visit the following web site:
www.ge-mcs.com/bently

Compliance and Certifications**EMC**

Standards:
EN 61000-6-2, Immunity for
Industrial Environments

European Community Directives
EMC 2004/108/EC

For further certification and approvals information please visit the following web site:
www.ge-mcs.com/bently

Environmental Limits**Operating
Temperature**

-40 °C to +85 °C (-40 °F to +185
°F).

**Storage
Temperature**

-40 °C to +100 °C (-40 °F to +212
°F).

Shock Limit

5000 g pk, maximum.

Humidity Limit

100% condensing,
non-submerged.

**Magnetic Field
Susceptibility**

<0.0068 mm/s/gauss (0.268
mil/s/gauss) @ 50 gauss, 50-60Hz

Mechanical**Weight**

<297 g (10.5 oz.), typical.

**Mounting
Surface**

33 mm diameter (1.3 in diameter).

Height

82 mm (3.2 in).

Case Material

316L stainless steel

Connector

2-pin 316L stainless steel MIL-C-
5015, top.

**Mounting
Torque**

4.5 N-m ± 0.6 N-m (40 in-lbf ± 5
in-lbf).

Polarity

Pin A goes positive with respect to Pin B when velocity is from base to top of the transducer.

Mounting Angle

Any orientation.

Ordering Information

Velomitor CT Velocity Transducer

190501-AA-BB-CC

A: Mounting Hardware Option

- 00 No stud
- 01 Stud 3/8-in 24 to 3/8-in 24
- 02 Stud 3/8-in 24 to 1/2-in 20
- 03 Adhesive Stud 3/8-in 24
- 04 Stud M6x1 with 3/8-in 24 adapter
- 05 Adhesive Stud M6x1 with 3/8-in 24 adapter
- 06 Stud 3/8-in 24 to 1/4-in 28
- 07 Plate Stud 3/8-in 24 to 3/8-in 24
- 08 Plate Stud 3/8-in 24 to 1/2-in 20
- 09 Plate Stud 3/8-in 24 to 1/4-in NPT
- 10 Plate Stud M6x1 to M6x1 with 3/8-in 24 adapter
- 11 Plate Stud 3/8-in 24 to 1/4-in 28
- 12 Plate Stud 3/8-in 24 to M8x1
- 13 Quick disconnect stud
- 14 Adapter, 3/8-in 24 to 1/4-in 20
- 15 Adapter, 3/8-in 24 to 5/16-in 18
- 16 Adapter, 3/8-in 24 to 3/8-in 24
- 17 Adapter, 3/8-in 24 to 3/8-in 16
- 18 Adapter, 3/8-in 24 to 1/2-in 13
- 19 Adapter, 3/8-in 24 to 1/4-in 18 NPT
- 20 Adapter, 3/8-in 24 to 3/8-in 18 NPT
- 21 Adapter, 3/8-in 24 to 1/2-in 14 NPT
- 22 Adapter, 3/8-in 24 to 3/4-in 14 NPT
- 23 Adapter, 3/8-in 24 to 1.0-in 11.5 NPT
- 24 Adapter, 3/8-in 24 to 1.25-in 11.5 NPT

B: Connection Option

- 00 MIL-C-5015 connection interface
- 99 Unit with included 32 foot cable

C: Agency Approval Option

- 00 No approvals
- 01 Multiple approvals
- 02 Multiple approvals
- 03 Multiple approvals
- 04 Multiple approvals

Interconnect Cable

CB2W100-AXXX

Description: Connectors: MIL-C 5015, 2 Socket, Splash Proof, Premium, isolated to blunt cut, Cable: 20 AWG, twisted pair, shielded, yellow Teflon® jacket. LOCKING RING, ADAPTER SEAL, AND O-RING ARE INCLUDED.

A: Length

- 015 15 feet (4.57 metres)
- 032 32 feet (9.75 metres)
- 064 64 feet (19.5 metres)
- 112 112 feet (34.1 metres)
- 125 125 feet (38.1 metres)
- 150 150 feet (45.7 metres)
- 200 200 feet (61.0 metres)

Accessories

125389-01

Velomitor CT Manual

128608-02

1.2-in NPT conduit adapter

04284020-01

Adhesive mount base kit. The adhesive mount base kit design is for machines with thin casings that do not permit drilling and tapping a mounting hole. Kit contains material (adhesive and bases) for 2 each 3/8-in 24 UNF adhesive-mount bases. One kit can outfit 2 Velomitor CT Transducers.

Spare Mounting Adapters

All mounting adapters are made from 300 series stainless steel.

Standard Studs	
04365657	3/8-in 24 to 3/8-in 24 stud
87910-01	3/8-in 24 to 1/2-in 20 stud
87931-01	M6x1 to M6x1 metric stud (requires metric adapter)
87055-01	3/8-in 24 to M6x1 metric adapter
89139-01	3/8-in 24 to 1/4-in 28 stud

Hex Plate Studs	
107756-01	3/8-in 24 to 3/8-in 24 plate stud
107755-01	3/8-in 24 to 1/2-in 20 plate stud
107754-01	3/8-in 24 to 1/4-in NPT plate stud
107757-01	M6x1 to M6x1 plate stud (requires metric adapter)
125094-01	3/8-in 24 to M8x1 metric plate stud
128038-01	3/8-in 24 to 1/4-in 28 Plate Stud

Quick Disconnect Components

The following three components are included with the quick disconnect mounting option for the Velomitor CT Transducer. The quick disconnect option allows you to remove the transducer without rotating it, allowing you to keep the cable connected to the transducer.

128689-01	3/8-in 24 to 1¾-in 16 quick disconnect stud base. Attached to the machine.
43055-01	1¾-in 16 mounting base nut. Interface between stud base and transducer piece.
128690-01	3/8-in 24 quick disconnect stud transducer piece. Attached to the Velomitor CT Transducer.

Fittings

Conduit fittings allow connection of flexible, metal, liquid-tight conduit or armor to the conduit adapter.

03839201	1/2-in NPT straight male conduit fitting. For connecting flexible, liquid-tight conduit to the conduit adapter or a weatherproof enclosure.
03850000	1/2-in NPT straight, male compression-type fitting. For connecting Teflon-coated 3/8-in stainless steel armor to the transducer or a weatherproof enclosure. Fitting will fit Teflon®- coated armor with a maximum outer diameter of 13.8 mm (0.543 in) (including Teflon thickness).

Teflon®-Coated Stainless Steel Armor

106924-AXX

Note: This part includes the Teflon-coated armor but not the cable. You will require 2 1/2-in NPT compression fittings (part number 03850000) to attach the armor to the conduit adapter and terminate it at an enclosure.

A: Armor Length Option in Feet

Order in increments of 10 ft (3.0 m)

Minimum Length: 10 ft (3.0 m)

Maximum Length: 60 ft (18.3 m)

Flexible Metal Conduit**14847-AXX****A:** Flexible Conduit Length Option in Feet

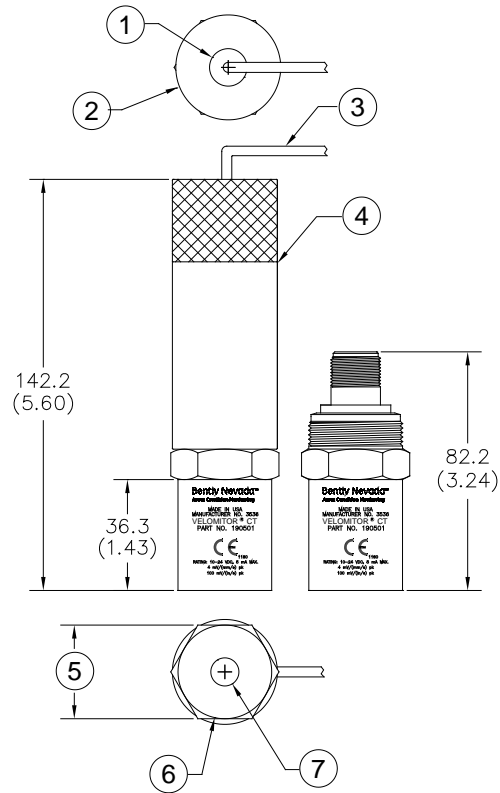
Order in increments of 1 ft (0.3 m)

Minimum Length: 01 ft (0.3 m)**Maximum Length:** 99 ft (30.2 m)**106769-01**

Terminal housing. Provides a convenient interface between the transducer signal cable and monitor signal cable.

Dimensional Drawings

Note: All dimensions shown are in millimeters (inches) unless noted otherwise.



1. 1/2" NPT x 12.2 DP (1/2" NPT x 0.48 DP)
2. 35.6 (1.40) diameter
3. Cable (not included)
4. Conduit adaptor P/N 128608-02 (not included)
5. 31.8 (1.25) hex flat
6. 31.5 (1.24) diameter
7. 3/8-24 UNF X 8.9 DP (3/8-24 UNF X 0.35 DP)

Figure 1: Velomitor CT Outline Drawing

Spare Mounting Adapters (Illustrations shown are not to scale)

Notes: All mounting adapters are made from 300 series stainless steel.

Table 1: Standard Studs






Part Number	Size	Illustration
04365657	3/8-24 to 3/8-24	
87055-01	3/8-24 to M6X1	
87910-01	3/8-24 to 1/2-20	
87931-01	M6X1 to M6X1	
89139-01	3/8-24 to 1/4-28	

Table 2: Adhesive Studs


Part Number	Size	Illustration
04284020	3/8-24	

Table 3: 1-3/8 Hex Plate Studs

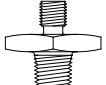
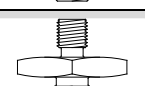
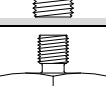
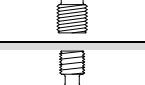
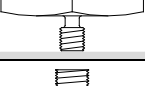
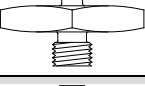

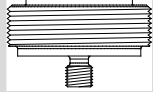
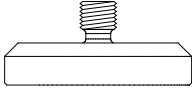
Part Number	Size	Illustration
107754-01	3/8-24 UNF to 1/4 NPT	
107755-01	3/8-24 UNF to 1/2-20 UNF	
107756-01	3/8-24 to 3/8-24	
197757-01	M6X1 to M6X1	
125094-01	3/8-24 UNF to M8X1	
128038-01	3/8-24 UNF to 1/4-28 UNF	

Table 4: Quick Disconnect Studs

Part Number	Description	Illustration
43055-01	Union Mounting Base Nut	
128689-01	Quick Disconnect Stud Base	
128690-01	Quick Disconnect Transducer Piece	

Graphs

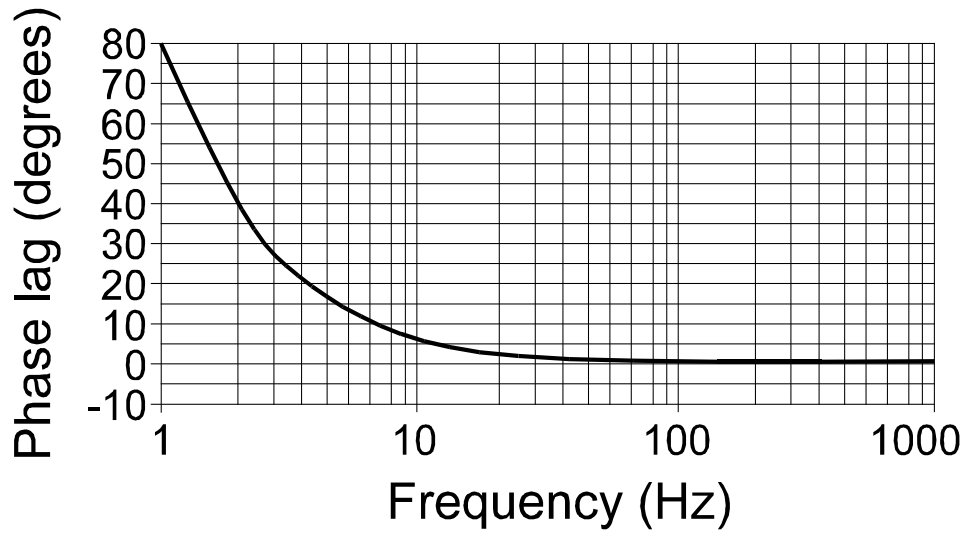


Figure 2: Typical Phase Response

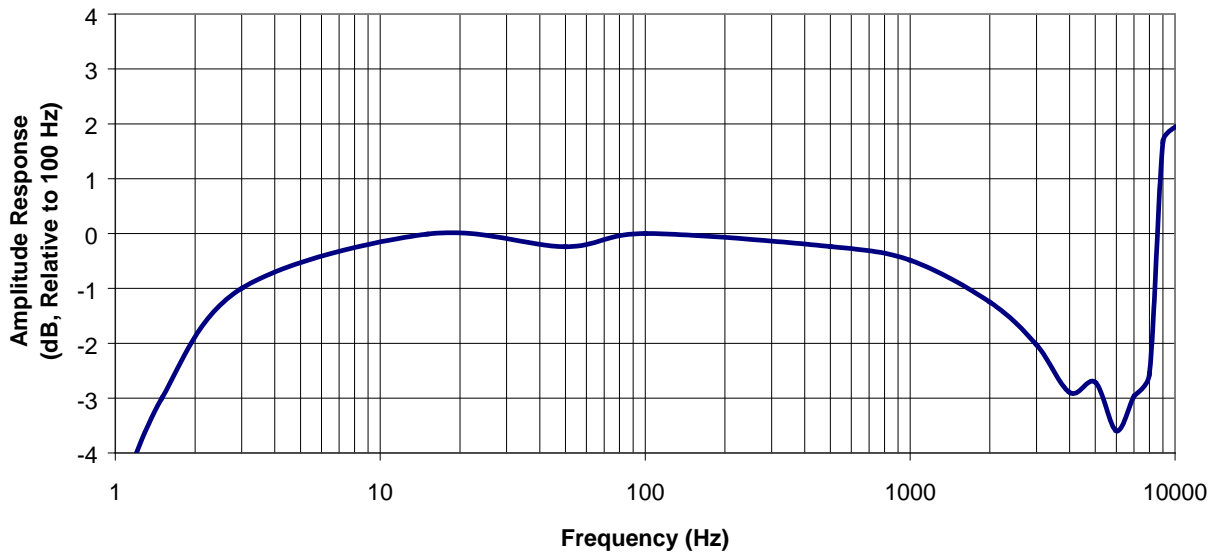
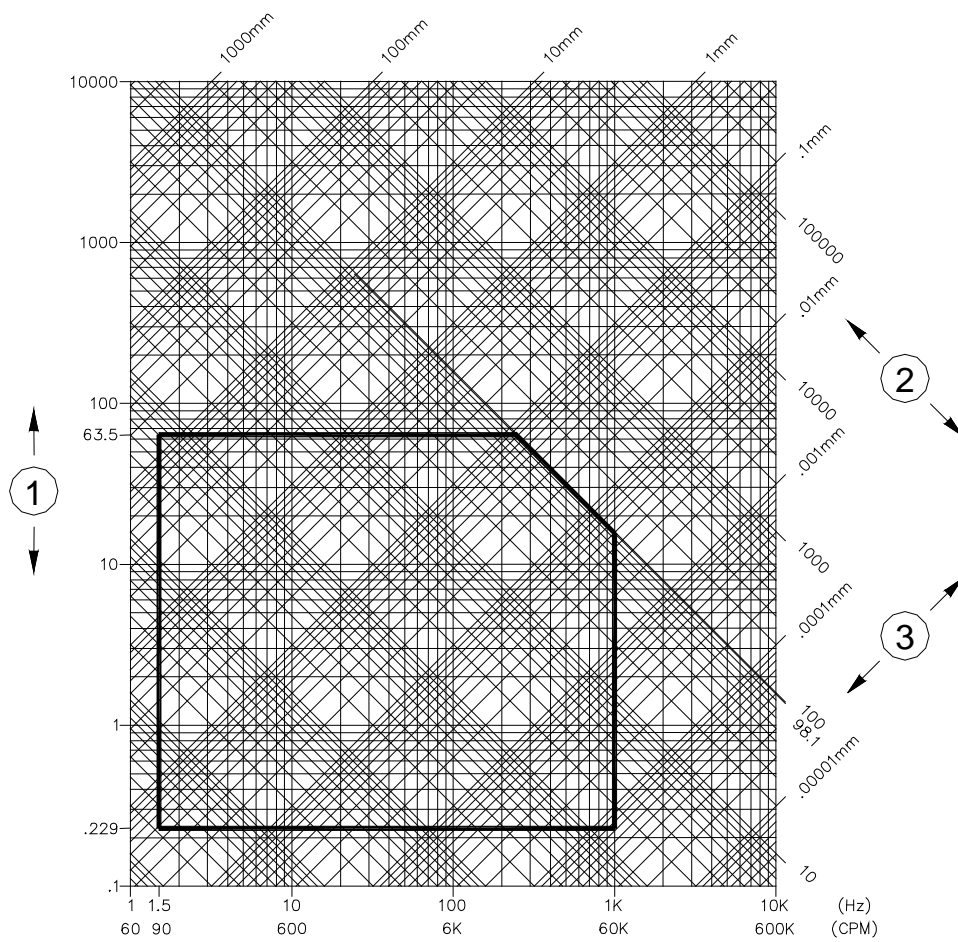
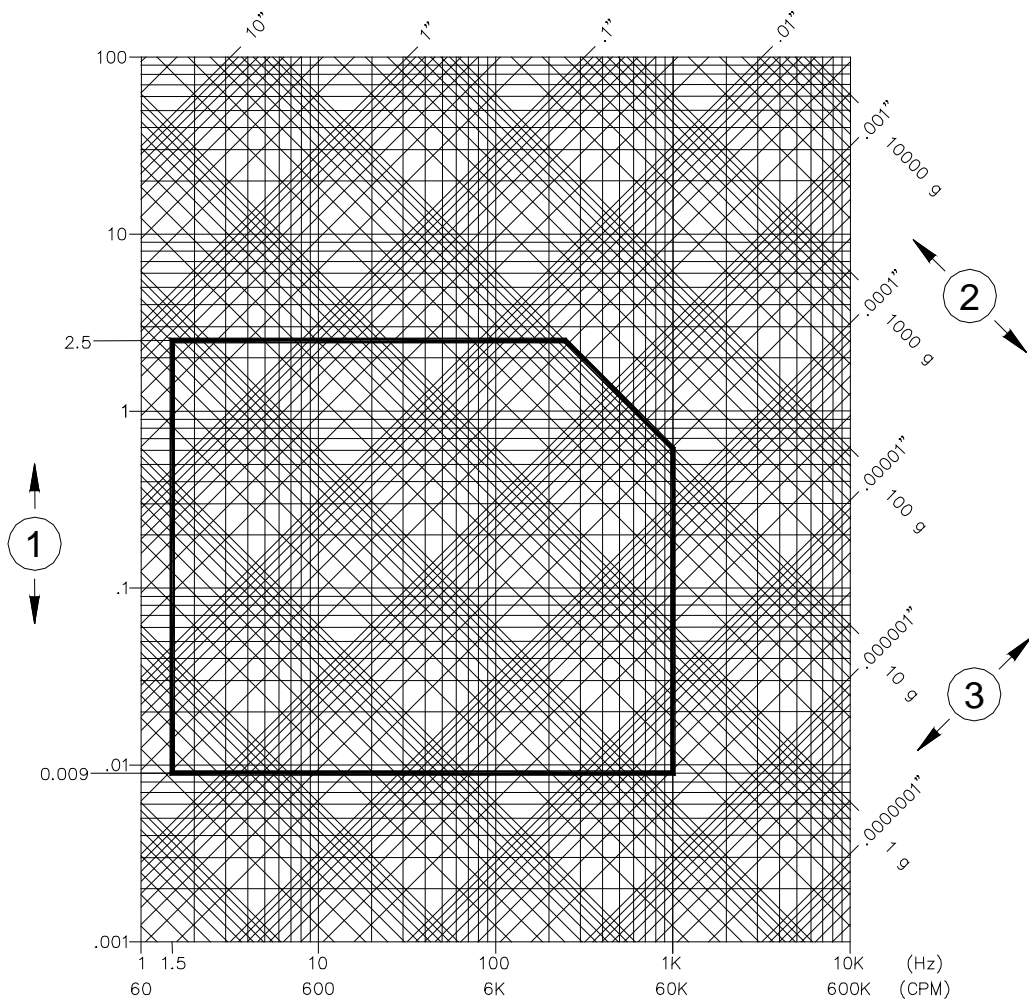


Figure 3: Typical Amplitude Response



1. Velocity axis (mm/s peak-peak)
2. Displacement axis (mm peak-peak)
3. Acceleration axis (m/s^2 peak-peak)

Figure 4: Operating Range for Metric Units



1. Velocity axis (in./s peak-peak)
2. Displacement axis (in. peak-peak)
3. Acceleration axis (g peak-peak)

Figure 5: Operating Range for English Units

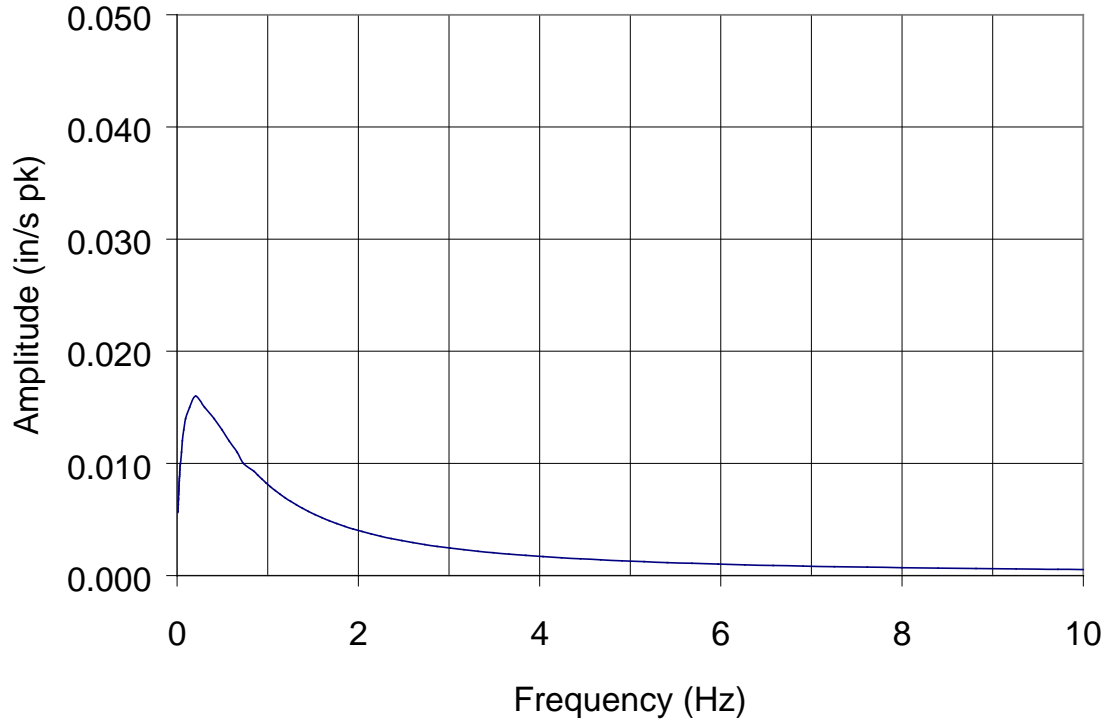


Figure 6: Typical Low Frequency Noise Floor

По вопросам продаж и поддержки обращайтесь: btn@nt-rt.ru

www.bently.nt-rt.ru

Архангельск (8182)63-90-72,
Астана+7(7172)727-132,
Белгород(4722)40-23-64,
Брянск(4832)59-03-52,
Владивосток(423)249-28-31,
Волгоград(844)278-03-48,
Вологда(8172)26-41-59,
Воронеж(473)204-51-73,
Екатеринбург(343)384-55-89
, Иваново(4932)77-34-06,
Ижевск(3412)26-03-58,
Казань(843)206-01-48,
Калининград(4012)72-03-81,
Калуга(4842)92-23-67,
Кемерово(3842)65-04-62,
Киров(8332)68-02-04,

Краснодар(861)203-40-90,
Красноярск(391)204-63-61,
Курск(4712)77-13-04,
Липецк(4742)52-20-81,
Магнитогорск(3519)55-03-13,
Москва(495)268-04-70,
Мурманск(8152)59-64-93,
Набережные Челны(8552)20-53-41
, Нижний Новгород(831)429-08-12,
Новокузнецк(3843)20-46-81,
Новосибирск(383)227-86-73,
Орел(4862)44-53-42,
Оренбург(3532)37-68-04,
Пенза(8412)22-31-16,
Пермь(342)205-81-47,
Ростов-на-Дону(863)308-18-15,

Рязань(4912)46-61-64,
Самара(846)206-03-16,
Санкт-Петербург(812)309-46-40,
Саратов(845)249-38-78,
Смоленск(4812)29-41-54,
Сочи(862)225-72-31,
Ставрополь(8652)20-65-13,
Тверь(4822)63-31-35,
Томск(3822)98-41-53,
Тула(4872)74-02-29,
Тюмень(3452)66-21-18,
Ульяновск(8422)24-23-59,
Уфа(347)229-48-12,
Челябинск(351)202-03-61,
Череповец(8202)49-02-64,
Ярославль(4852)69-52-93



BENTLY
Nevada